

# GPDN5113

RECTIFIER DIODE

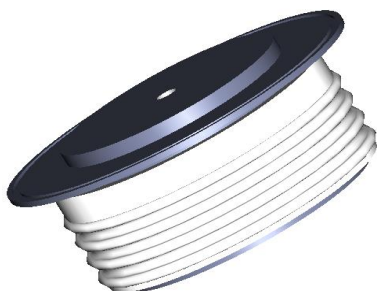

**BLOCKING VOLTAGE UP TO** 5000 V  
**AVERAGE CURRENT** 1135 A  
**SURGE CURRENT** 12 kA

## BLOCKING CHARACTERISTICS

Characteristic	Conditions	Value
V <sub>RRM</sub>	Repetitive peak reverse voltage	5000 V
V <sub>RSM</sub>	Non-repetitive peak reverse voltage	5100 V
I <sub>RRM</sub>	Repetitive peak reverse current, max.	V <sub>RRM</sub> , single phase, half wave, T <sub>jmax</sub> 50 mA

## FORWARD CHARACTERISTICS

I <sub>F(AV)</sub>	Average forward current	Sine wave, 180° conduction, T <sub>h</sub> = 55°C	1135 A
I <sub>F(RMS)</sub>	R.M.S. forward current	Sine wave, 180° conduction, T <sub>h</sub> = 55°C	1783 A
I <sub>FSM</sub>	Surge forward current	Non rep. half sine wave, 50 Hz, V <sub>R</sub> = 0 V, T <sub>j</sub> = T <sub>jmax</sub>	12 kA
I <sup>2</sup> t	I <sup>2</sup> t for fusing coordination		720 kA <sup>2</sup> s
V <sub>F(TO)</sub>	Threshold voltage	T <sub>j</sub> = T <sub>jmax</sub>	0.894 V
r <sub>F</sub>	Forward slope resistance	T <sub>j</sub> = T <sub>jmax</sub>	0.487 mΩ
V <sub>FM</sub>	Peak forward voltage, max	Forward current I <sub>F</sub> = 1500 A, T <sub>j</sub> = T <sub>jmax</sub>	1.62 V

## SWITCHING CHARACTERISTICS

Q <sub>rr</sub>	Reverse recovery charge, typ	T <sub>j</sub> = T <sub>jmax</sub> , I <sub>F</sub> = A, di/dt = A/μs	μC
I <sub>rr</sub>	Reverse recovery current		A

## THERMAL AND MECHANICAL CHARACTERISTICS

R <sub>th(j-c)</sub>	Thermal resistance (junction to case)	Double side cooled	0.034 °C/W
R <sub>th(c-h)</sub>	Thermal resistance (case to heatsink)	Double side cooled	0.007 °C/W
T <sub>jmax</sub>	Max operating junction temperature		160 °C
T <sub>stg</sub>	Storage temperature		-40 / 160 °C
F	Clamping force ± 10%		11 kN
	Mass		300 g

Current rating - sine wave

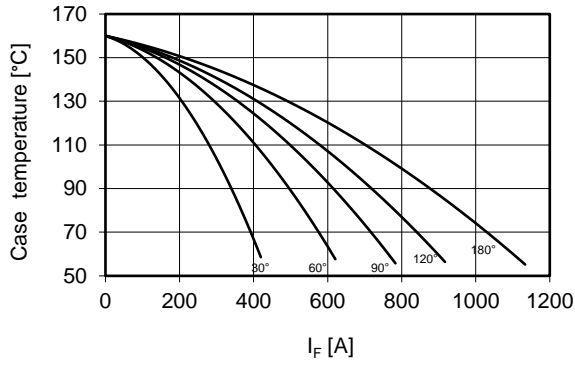

Power loss - sine wave

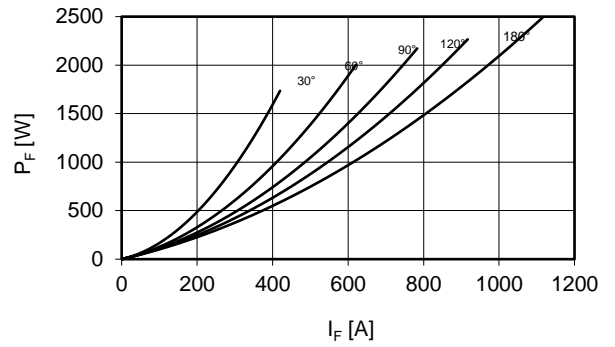

Maximum surge current d.s. cooled

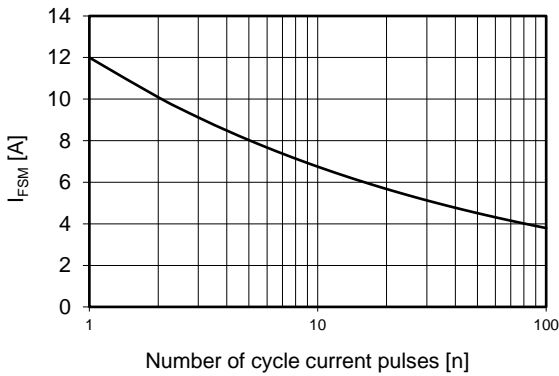

Forward voltage drop

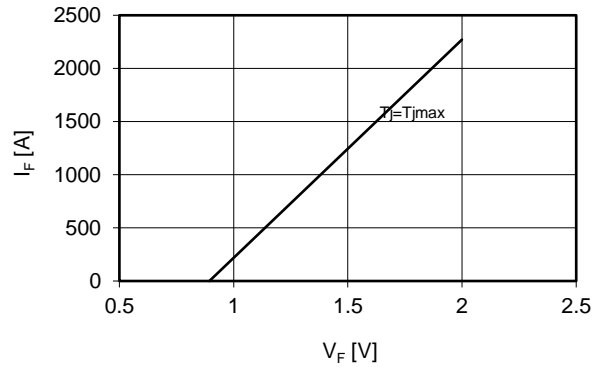

Thermal Impedance (j-c)

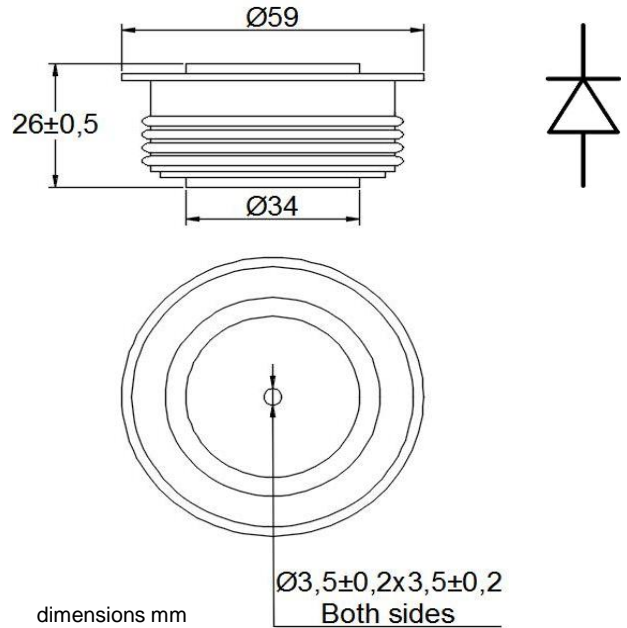
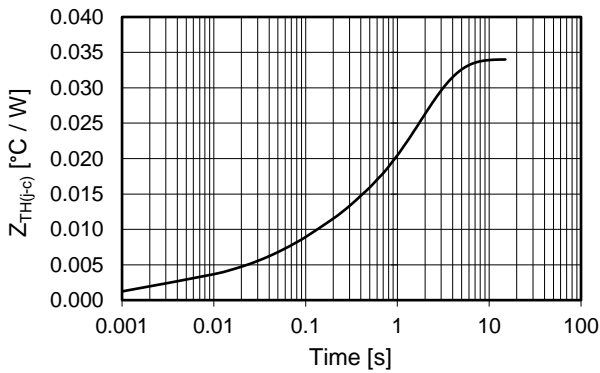

Ordering information GPDN5113-VV

VV: blocking voltage / 100 (e.g. 50 for 5000V)

In the interest of product improvement Green Power Solutions reserves the right to change any specification given in this data sheet without notice.