

GPTP3182

PHASE CONTROLLED SCR

High reliability operation
 DC power supply
 AC drives

VOLTAGE UP TO 2200 V
AVERAGE CURRENT 1825 A
SURGE CURRENT 26 kA

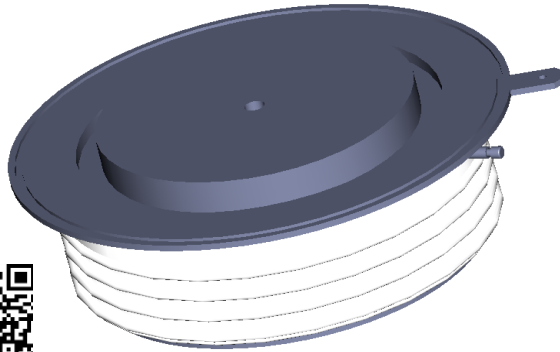

BLOCKING CHARACTERISTICS

Characteristic		Conditions	Value
VRRM	Repetitive peak reverse voltage		2200 V
VRSM	Non-repetitive peak reverse voltage		2200 V
VDRM	Repetitive peak off-state voltage		2300 V
IDRM	Repetitive peak off-state current, max.	VDRM, single phase, half wave, T _j = T _{jmax}	150 mA
IRRM	Repetitive peak reverse current, max.	VRRM, single phase, half wave, T _j = T _{jmax}	150 mA

ON-STATE CHARACTERISTICS

I _{T(AV)}	Average on-state current	Sine wave, 180° conduction, Th = 55 °C	1825 A
I _{T(RMS)}	R:M:S on-state current	Sine wave, 180° conduction, Th = 55 °C	2865 A
I _{TSM}	Surge on-state current	Non rep. half sine wave, 50 Hz, V _R = 0 V, T _j = T _{jmax}	26 kA
I ² t	I ² t for fusing coordination		3380 kA ² s
V _{T(TO)}	Threshold voltage	T _j = T _{jmax}	0.992 V
r _T	On-state slope resistance	T _j = T _{jmax}	0.206 mΩ
V _{TM}	Peak on-state voltage, max	On-state current I _T = 2000 A, T _j = T _{jmax}	1.40 V
I _H	Holding current, typ	T _j = 25 °C	200 mA
I _L	Latching current, typ	T _j = 25 °C	450 mA

TRIGGERING CHARACTERISTICS

V _{GT}	Gate trigger voltage	T _j = 25 °C, V _D = 5 V	3.0 V
I _{GT}	Gate trigger current	T _j = 25 °C, V _D = 5 V	250 mA
V _{GD}	Non-trigger voltage	V _D = 67% VRRM, T _j = T _{jmax}	0.3 V
P _{GM}	Peak gate power dissipation	Pulse width 100 μs	150 W
P _{G(AV)}	Average gate power dissipation		3 W
I _{FGM}	Peak gate current		10 A
V _{FGM}	Peak gate voltage (forward)		12 V
V _{RGM}	Peak gate voltage (reverse)		10 V

SWITCHING CHARACTERISTICS

di/dt	Critical rate of rise of on-state current	T _j = T _{jmax}	200 A/μs
dV/dt	Critical rate of rise of off-state voltage	T _j = T _{jmax}	1000 V/μs
t _q	Turn-off time, typ	T _j = T _{jmax} , I _T = 1000 A, di/dt = -20 A/μs	μs
		V _R = 50 V, V _D = 67% VDRM, dV/dt = 20 V/μs	

THERMAL AND MECHANICAL CHARACTERISTICS

R _{th(j-c)}	Thermal resistance (junction to case)	Double side cooled	0.015 °C/W
R _{th(c-h)}	Thermal resistance (case to heatsink)	Double side cooled	0.006 °C/W
T _{jmax}	Max operating junction temperature		125 °C
T _{stg}	Storage temperature		-40 / 125 °C
F	Clamping force ± 10%		22 kN
	Mass		520 g

Current rating - sine wave

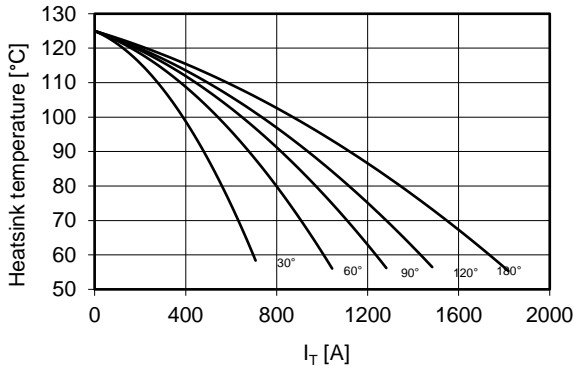

Power loss - sine wave

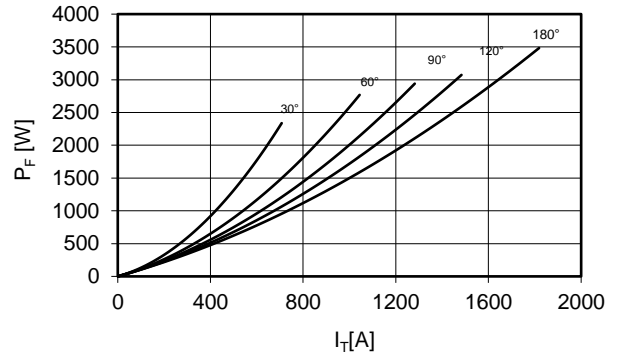

Maximum surge current d.s. cooled

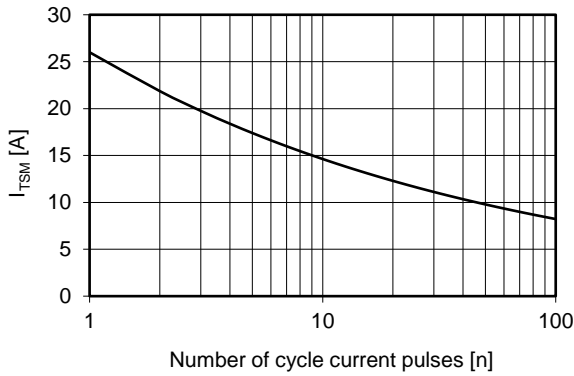

On-state voltage drop

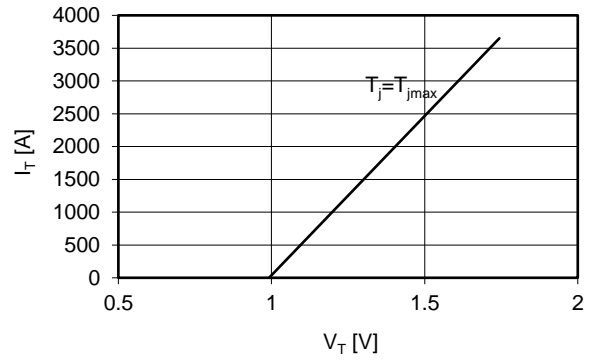

Thermal impedance (j-c)

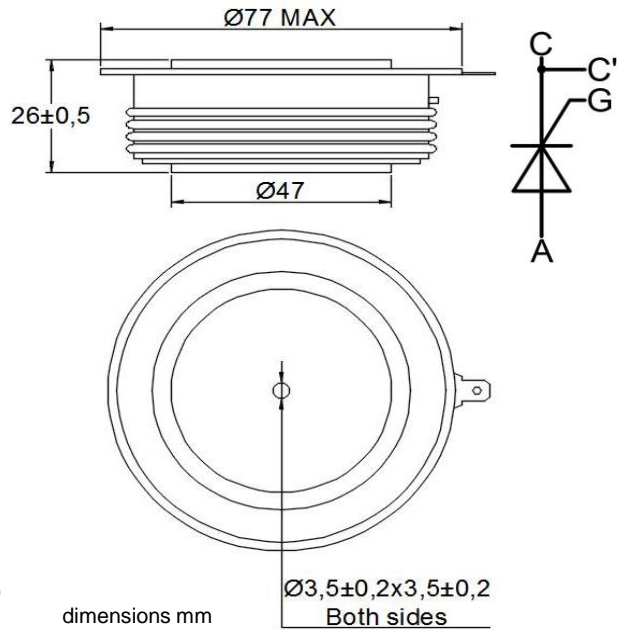
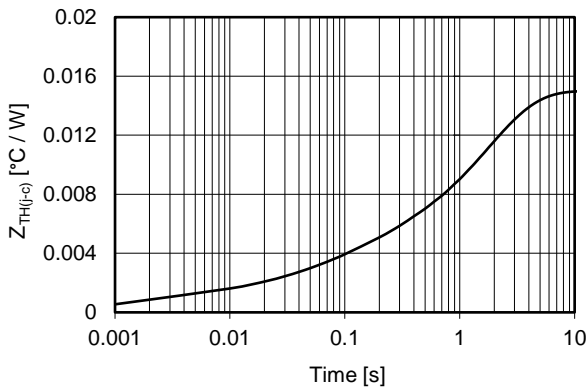

Ordering information GPTP3182-VVGL

- VV**: blocking voltage / 100 (e.g. 22 for 2200 V)
- G**: trigger lead type (**S** = straight **T** = twisted **blank** = no leads)
- L**: trigger lead length x 100mm (**3 - 4 - 5 - 7 blank** = no leads)

In the interest of product improvement Green Power Solutions reserves the right to change any specification given in this data sheet without notice.