

# GPTR5230

## PHASE CONTROLLED SCR

High reliability operation  
 DC power supply  
 Controlled rectifiers  
 DC drives - Motor starters

**BLOCKING VOLTAGE UP TO**      **4400 V**  
**AVERAGE CURRENT**              **2300 A**  
**SURGE CURRENT**                    **37 kA**

### BLOCKING CHARACTERISTICS

Characteristic		Conditions	Value
V <sub>RRM</sub>	Repetitive peak reverse voltage		4400 V
V <sub>RSM</sub>	Non-repetitive peak reverse voltage		4500 V
V <sub>DRM</sub>	Repetitive peak off-state voltage		4400 V
I <sub>DRM</sub>	Repetitive peak off-state current, max.	V <sub>DRM</sub> , single phase, half wave, T <sub>j</sub> = T <sub>jmax</sub>	300 mA
I <sub>RRM</sub>	Repetitive peak reverse current, max.	V <sub>RRM</sub> , single phase, half wave, T <sub>j</sub> = T <sub>jmax</sub>	300 mA

### ON-STATE CHARACTERISTICS

I <sub>T(AV)</sub>	Average on-state current	Sine wave, 180° conduction, Th = 55 °C	2300 A
I <sub>T(RMS)</sub>	R.M.S. on-state current	Sine wave, 180° conduction, Th = 55 °C	3613 A
I <sub>TSM</sub>	Surge on-state current	Non rep. half sine wave, 50 Hz, V <sub>R</sub> = 0 V, T <sub>j</sub> = T <sub>jmax</sub>	37 kA
I <sup>2</sup> t	I <sup>2</sup> t for fusing coordination		6845 kA <sup>2</sup> s
V <sub>T(TO)</sub>	Threshold voltage	T <sub>j</sub> = T <sub>jmax</sub>	1.20 V
r <sub>T</sub>	On-state slope resistance	T <sub>j</sub> = T <sub>jmax</sub>	0.300 mΩ
V <sub>TM</sub>	Peak on-state voltage, max	On-state current I <sub>T</sub> = 3000 A, T <sub>j</sub> = T <sub>jmax</sub>	2.10 V
I <sub>H</sub>	Holding current, max	T <sub>j</sub> = 25 °C	300 mA
I <sub>L</sub>	Latching current, typ	T <sub>j</sub> = 25 °C	1500 mA

### TRIGGERING CHARACTERISTICS

V <sub>GT</sub>	Gate trigger voltage	T <sub>j</sub> = 25 °C, V <sub>D</sub> = 12 V	3 V
I <sub>GT</sub>	Gate trigger current	T <sub>j</sub> = 25 °C, V <sub>D</sub> = 12 V	300 mA
V <sub>GD</sub>	Non-trigger voltage	V <sub>D</sub> = 67% V <sub>RRM</sub> , T <sub>j</sub> = T <sub>jmax</sub>	0.35 V
P <sub>GM</sub>	Peak gate power dissipation	Pulse width 0.5 ms	150 W
P <sub>G(AV)</sub>	Average gate power dissipation		5 W
I <sub>FGM</sub>	Peak gate current		10 A
V <sub>FGM</sub>	Peak gate voltage (forward)		30 V
V <sub>RGM</sub>	Peak gate voltage (reverse)		5 V

### SWITCHING CHARACTERISTICS

di/dt	Critical rate of rise of on-state current	T <sub>j</sub> = T <sub>jmax</sub>	200 A/μs
dV/dt	Critical rate of rise of off-state voltage	T <sub>j</sub> = T <sub>jmax</sub>	1000 V/μs
t <sub>q</sub>	Turn-off time, typ	T <sub>j</sub> = T <sub>jmax</sub> , I <sub>T</sub> = 2300 A, di/dt = -10 A/μs V <sub>R</sub> = 100 V, V <sub>D</sub> = 67% V <sub>DRM</sub> , dV/dt = 50 V/μs	630 μs

### THERMAL AND MECHANICAL CHARACTERISTICS

R <sub>th(j-c)</sub>	Thermal resistance (junction to case)	Double side cooled	0.009 °C/W
R <sub>th(c-h)</sub>	Thermal resistance (case to heatsink)	Double side cooled	0.002 °C/W
T <sub>jmax</sub>	Max operating junction temperature		125 °C
T <sub>stg</sub>	Storage temperature		-40 / 125 °C
F	Clamping force ± 10%		45 kN
	Mass		1500 g

Current rating - sine wave

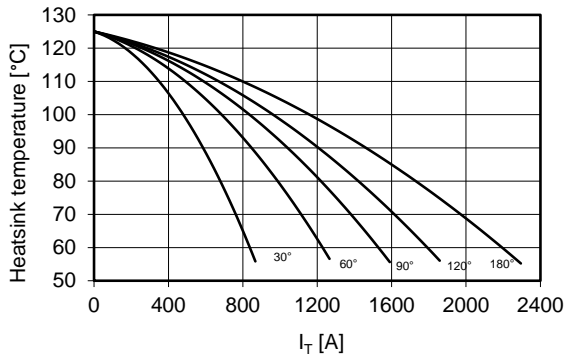

Power loss - sine wave

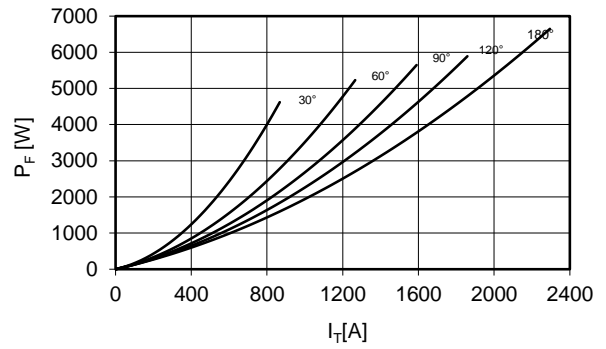

Maximum surge current  
d.s. cooled

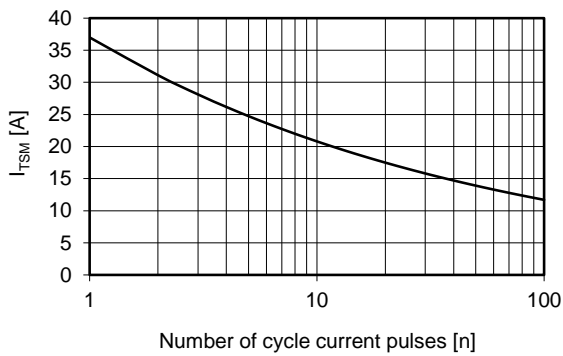

On-state voltage drop

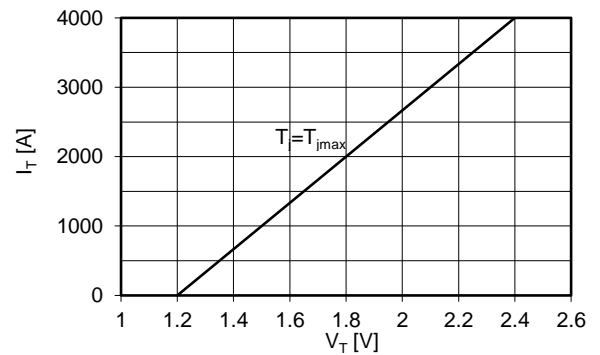

Thermal impedance (j-c)

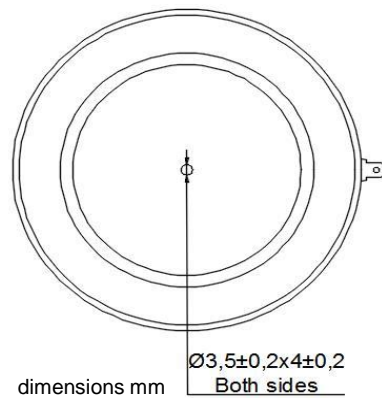
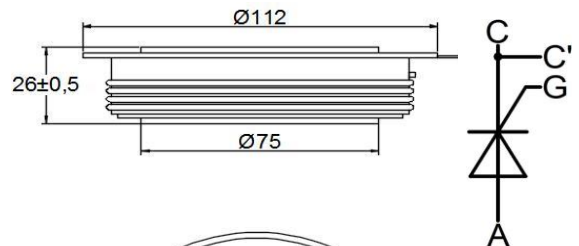
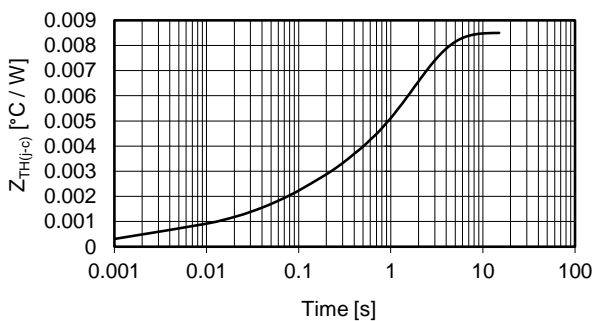

**Ordering information GPTR5230-VVGL**

- VV**: blocking voltage / 100 (e.g. 44 for 4400 V)
- G**: trigger lead type (**S** = straight **T** = twisted **blank** = no leads)
- L**: trigger lead length x 100mm (**3 - 4 - 5 - 7 blank** = no leads)

In the interest of product improvement Green Power Solutions reserves the right to change any specification given in this data sheet without notice.